

EXHIBITION
DISPLAY
INTERIOR SOLUTIONS

PROFILE 43TX



The System with profile
since 1965

PROFILE 43TX FABRIC

– Strong profile for exhibition solutions!

With our double-sided fabric profile 43TX you can create exclusive frames where only the image is visible from the front. The anodized frame creates an elegant and clean area around the image. The corners are cutted 45 degrees and are held together with a coupling. This profile is especially useful when building booth because of its strength.

Around the fabric image you sew a thin silicon strip. The strip is then folded into the groove of the aluminum profile and attaches the image. Picture change goes very fast.

We cut the profiles to customer requirements. Maximum length is 5000 mm.

Frame depth is 40 mm.



FACTS:

Natural anodised aluminium profile 43TX is supplied in 5m stock lengths or can be cut to custom sizes.

Recommended media: Stretch fabric

Art No	Description	Size	Packaging
43TX	Profile 43TX	40x5000x40 mm	100 m
613	Coupling 613	60x7x60 mm	100 pcs
350 TX	Silicon strip 350 TX	3x14 mm	100 m

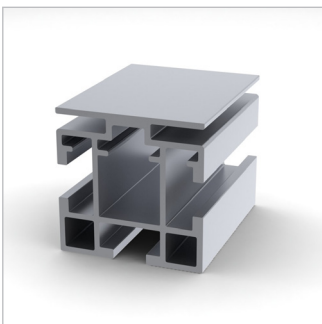

Profile 43TX is for double sided graphics.

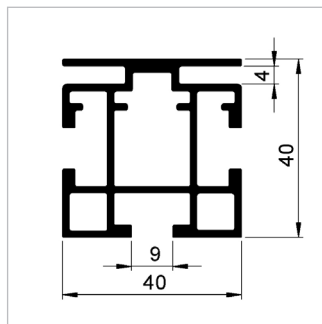

43TX profile dimensions.



Mitered corner of profile 43TX.

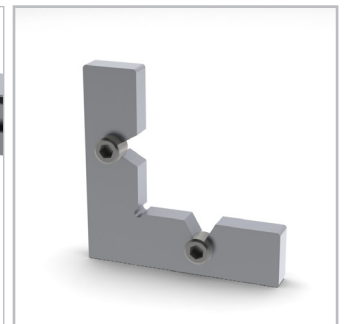

Coupling 613.